

INSTRUMENTATION

DETECTORS, ANALYZERS, AND PURIFIERS

NEW! MULTICHANNEL TEMPERATURE PROGRAMMER FOR FAST GC

- Eliminates hot and cold spots in high speed GC!
- Up to four independently programmable zones with eight states of rapid heating and cooling
- For use with nickel-wire-wrapped resistively-heated columns
- The single nickel wire serves as heating element and temperature sensor
- Terminal mode control or user-friendly interface and control/monitor program running on Windows
- Can be designed into your portable GC or added to any existing GC or analyzer

SPECIFICATIONS

Number of heated zones	1 to 4
Programmable temperature states	8 per zone
Max ramp rate	5 m column 1,200°C/min 15 m column 500°C/min
Accuracy	Isothermal 0.1°C Programmed <0.5°C, in most cases
Interfaces	RS-232, GPIO
Dimensions	6" w x 5" h x 4.75" deep

The FTP-200 is a highly-configurable temperature controller with as many as four channels that can be programmed to ramp independently or simultaneously. The zones use a temperature-predictive algorithm and thermocouple or RTD input for precise control of multiple columns or related transfer lines, injector, etc. The controller operates at a high frequency, allowing precise control of ramping rates as high as 2000° C per minute.

The primary channel, specifically designed for precision temperature programming of low mass nickel-wire-wrapped columns, utilizes the nickel as both the heating element and the temperature sensor. This reduces the mass of the column, reduces the lag time between target temperature and actual temperature, and enables the use of a safe, low voltage to heat the column. A small fan cools the column to the starting temperature.

A graphical user interface, or GUI, provides user-friendly programming and data reporting. For users who prefer basic operation with raw data, control via a set of serial commands is accomplished via a terminal emulation or communication software running on a PC-compatible computer.

ORDERING INFORMATION

The FTP-200 can be configured many ways. The simplest version has only the main channel; the maximum is four. Beyond that, it can be ordered with or without an enclosure, and with or without a power supply. If it has a power supply, it can be specified with a US power cord, a European power cord, or no power cord at all. There is also a choice of temperature-sensing options.

After the basic controller is configured, the column/fan, transfer lines, and other possible options must be considered. Contact VICI to discuss your needs.

NEW! COLUMN/FAN MODULES

- For use with our FTP-200 multichannel temperature programmer
- Includes column, fan, transfer lines, sensors, and connections in one unit
- Wide selection of column types, sizes, and phases
- Choice of high-flow fans for fast cooling
- Resistively-heated transfer lines with a low mass 40 gauge "K" thermocouple

When you buy an FTP-200 and specify the components to be assembled into one of these modules, the FTP-200 and module leave the factory configured for plug-and-play implementation.

Shown below is an example used to produce a one minute SimDis analysis.

SYSTEM SCHEMATIC: SimDis ANALYSIS

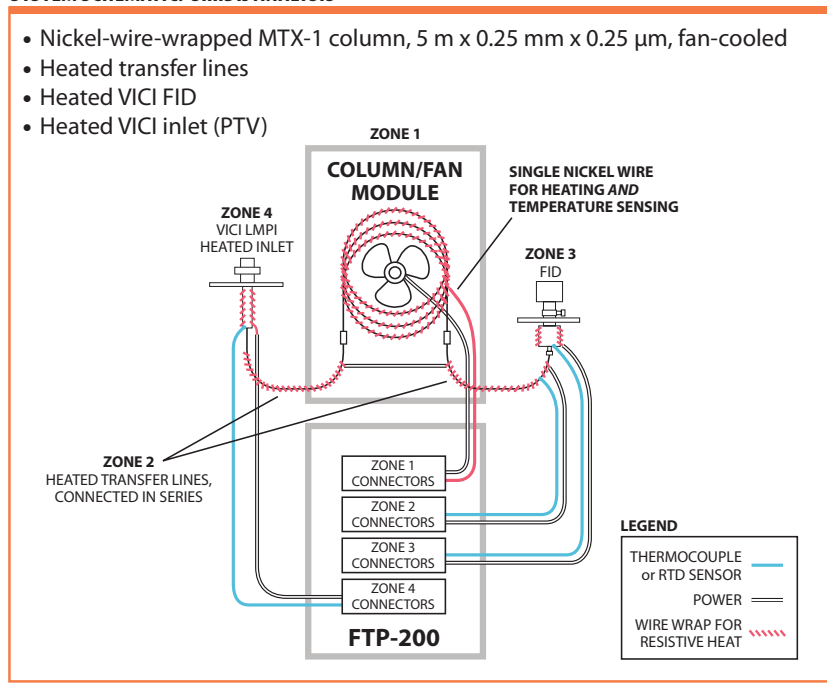

OPTIONS	
Column	Fused silica, metal, or packed Any phase 1 m x 100 µm to 30 m x 530 µm
Fan	60 mm, 92 mm, or 120 mm 12, 24, or 48 VDC
Transfer lines	Choice of lengths up to 1 meter
Mounting	Wall mount or free-standing, with or without legs

1 MINUTE SimDis ANALYSIS WITH THE FTP-200

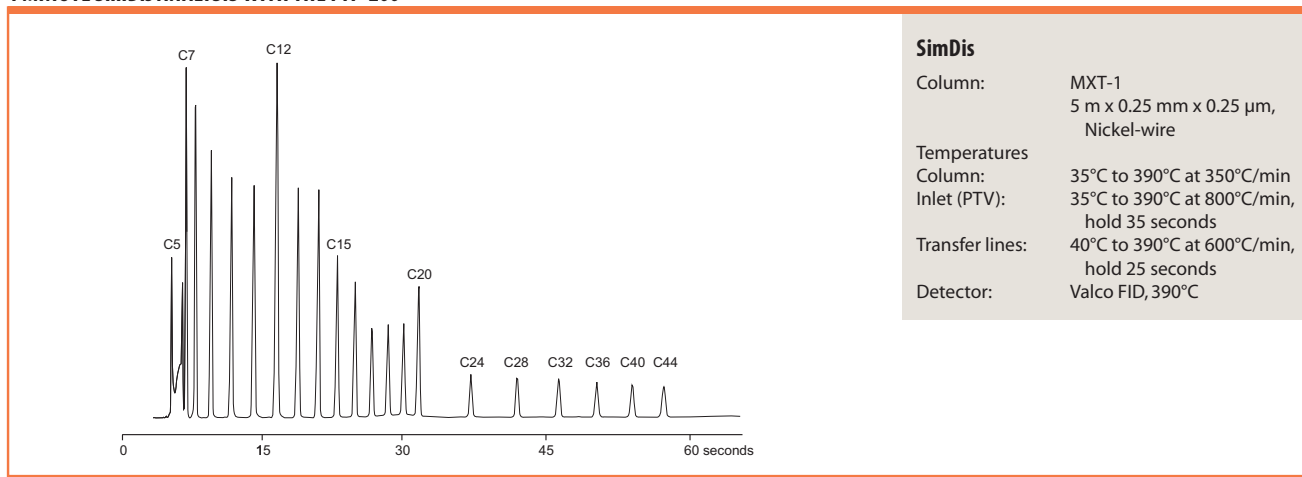

TRACE GAS ANALYZERS

- Suitable for lab, process, or mobile application
- MDQs for most analytes < 1 ppb
- Turnkey applied gas chromatograph
- MDQs for most analytes < 1 ppb
- Fully integrated, stand-alone operation
- Fast temperature zones

VICI Trace Gas Analyzers (TGAs) are fully configured and tested gas chromatographs designed for use in high purity and ultra high purity analysis. Each instrument is fully configured and tested per user requirements. A full documentation package delivered with each instrument includes a method validation report, capability data, bill of materials, and method parameters.

LAB, PROCESS, OR MOBILE

Trace Gas Analyzers can be set up for single run analysis or batch sampling, or to run continuously for process monitoring. This makes the TGA an ideal option for bench-top applications in the lab or for continuous duty in a process. With options for sampling by valve, syringe port, or the optional sampling system, the instrument can do batch or individual analysis from a fill manifold or trailer fill stanchion, or from a variety of sample points in a process.

MDQS < 1 PPB

Currently our conservative guarantee for MDL with a reasonable RSD is 10 ppb for atmospheric components, day-in and day-out. But some of our clients find that once the analyzer is installed and running continuously in ultra high purity applications, the instruments are able to routinely integrate and quantify at levels of less than 1 ppb. For multiple method applications, this very low LDL can be coupled with range extension up to 100%.

TURNKEY ANALYZER

Configurations for most bulk, specialty, and electronics gases are available. Standard configurations include He, H₂, N₂, Ar, O₂, BF₃, CO, CO₂, CH₄, C₂H₄, C₃H₆, CF₄, C₂F₆, C₃F₈, NF₃, HBr, AsH₃, PH₃, B₂H₆, SiF₄, and SiH₄.

STAND-ALONE OPERATION

VICI TGAs provide a complete stand-alone solution for autonomous chromatographic analysis, from sample prep to final report. Everything is included in the TGA housing, from the computer with all the necessary software and hardware to the touch-enabled wide screen display. A wireless mouse and keyboard are also included.

Resultant data can be printed via a network printer or to a local user-provided printer. The base instrument provides results displayed on the front panel, transmitted through the RS-232 serial port, and published through the OPC server. Optional outputs include 4-20 mA analog trending, as well as Modbus and Profibus communication protocols. With the optional Statistical package, results of averaged samples can be easily acquired for use in calibration and system validation checks. Functionality for copper-based LAN or optional WIFI connection make the instrument available and data accessible.

FAST TEMPERATURE ZONES

Optional Fast Temperature Programmer (FTP) technology can be used for up to four temperature zones.

Those zones can be columns, preconcentrators, heated transfer lines, traps, valves, or detectors.

Ramping capability varies based upon the mass of the item to which the heat is being applied. For example, a 5 m x .32 mm fused silica capillary column can be ramped and controlled at rates up to 3000°C/min, while a 30 m MXT style column may only ramp at 120°C/min.

Each zone can be run independently or programmed to track another zone. Each independent zone also has accommodation to power a fan or cryo-valve as the means of rapid cooling.

! UNPARALLELED VICI EXPERTISE

While VICI TGAs embody the latest improvements in the VICI Trace Gas Analyzer product line, we have been a standard for analysis in the pure gas industry for more than 35 years.

We continue to be the primary manufacturer of every major component in our systems, from valves and detectors to electrometers.

MODULAR DESIGN

The design of the TGA allows a very wide range of applications to be run on a single instrument. The standard modules are:

- **Detectors**

Standard configurations use one or two detectors; however, with the modular approach as many as eight detectors can be used. Depending on the requirements detectors can be run in parallel or in series.

Detectors can be any combination of FID, microTCD, IMS, RGD, or pulsed discharge detectors (PDDs) operating in PDHID, PDPID, or PDECD modes. For example, a PDHID and a microTCD running the same sample provide a useable range from <5 ppb up to >99% concentration.

- **Oven/temperature zones**

The TGA offers support for 12 programmable thermal zones and up to four fast temperature programmed (FTP) zones. FTP zones can be micropacked columns, metal open tubular columns, capillary columns, programmable rate injectors, vaporizers, retention gap, or absorbers/concentrators.

- **Valve controls**

Support is available for up to 16 air actuated and four electrically actuated two position valves, plus four electrically actuated multiposition valves.

TGAs can be specified with an optional Gas Sampling System (GSS), which provides up to 64 streams and four calibration gases and associated methods. When a TGA is configured with the GSS option, the user can enable a batch routine to introduce a selected sample and method, run the analysis with replicates, store the data, integrate the chromatogram, and calculate the results.

The Automatic Calibration option is a configuration that allow user-configurable system suitability checks to be run within a batch of samples or at particular times of day.

LINEAR DYNAMIC RANGE OF TGA DETECTOR OPTIONS

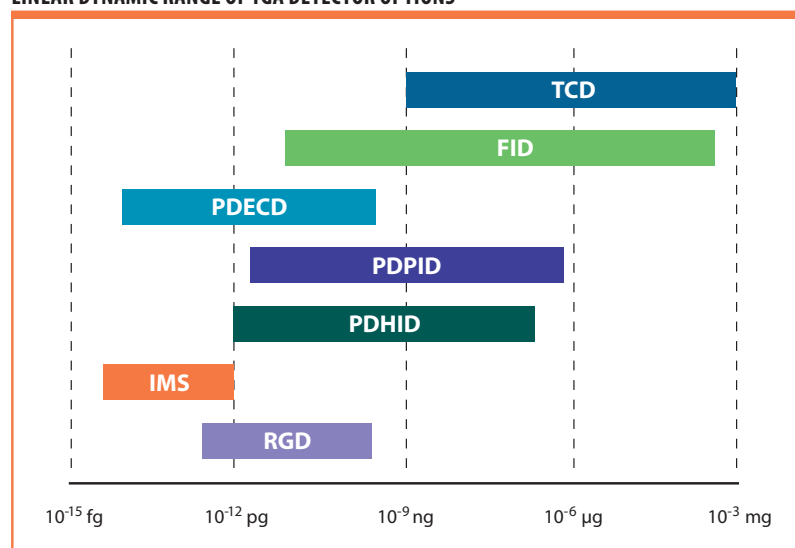

i FOR MORE INFORMATION

We'd be happy to discuss how a TGA could work with your application and requirements. Just give us a call.

→ SEE ALSO

Microvolume
TCD page 217
Pulsed discharge detectors..... 210-215

ADVANTAGES OF MODULAR DESIGN

Redundancy

In addition to the wide dynamic range and low level sensitivity, the TGA can be configured for redundancy so that there is always a hot backup for any two-channel method.

Multiple methods

With the highly flexible graphical user interface (GUI), a single TGA with two or more detectors can be configured for a wide range of methods on a wide variety of gas types. We routinely provide instruments with the standard two detectors plus two additional detectors added as an option. In this setup, two detectors are configured with methods for five or more bulk gases, while the other two run another method and gas type or remain on standby as "hot backup".

Higher throughput, high speed ovens

If you need to clear heavy compounds or contamination from an injected sample or require a long ramping method for a series of compounds, we can configure one or more modular fast temperature programmed zones to drastically increase throughput. As an added benefit, the FTP zones improve peak shape and height-to-width ratios, which translates into lower LDL performance

Simplified service

TGA configuration is often highly modular (depending on the analysis), simplifying service and replacement if there is ever a need. If the methods and service requirements for your instrument ever change, the modular design also allows a much easier path for upgrades.

SPECIFICATIONS

	TGA6K4U	TGA6K7U
Dimensions	43.2 cm W x 59.7 cm L x 17.8 cm H	43.2 cm W x 55.9 cm L x 31.1 cm H
Weight	13.6 kg	20.4 kg
Max. number of detectors	2	2
Carrier gas	Purified helium Detector and sample gas dependent	
Carrier gas flow rate	< 70 ml/min per detector, regulated @ 80 psig	
Actuator gas	Helium or instrument air regulated @ 60 psig	
Electrical requirements	100-120 VAC or 220-240 VAC, 50/60 Hz	

TELEMETRY OPTIONS

While the TGA is a fully functional standalone GC, there are those times when a brief look is all that is required to verify that a batch of samples is running smoothly. Why put on your PPE and walk out into the plant or waltz across the lab to check? Just point your PC browser to the TGA's optional secure web-based interface, provide the proper user name and password, and access the full functionality of the TGA.

We can provide remote support through a number of methods which can be tailored to your company's security policies. With appropriate IT approval/assistance, the TGA can be accessed through a secure connection from the internet, allowing a technician to provide needed assistance without a road trip for a service call. A real time and money saver! And remote support after the sale is free for life with a Valco TGA.

TRACE IMPURITIES in ARGON 1 ml of 1 ppm blend

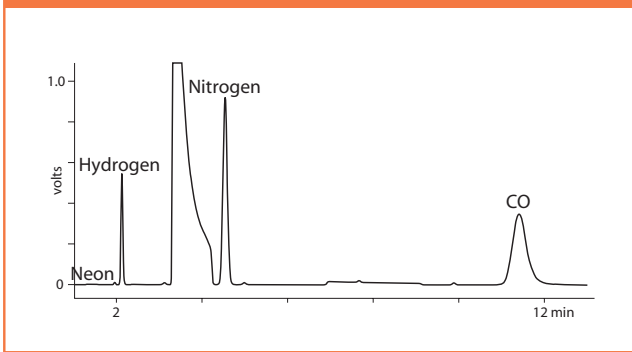

TRACE IMPURITIES in HELIUM 1 ml of 2 ppm blend

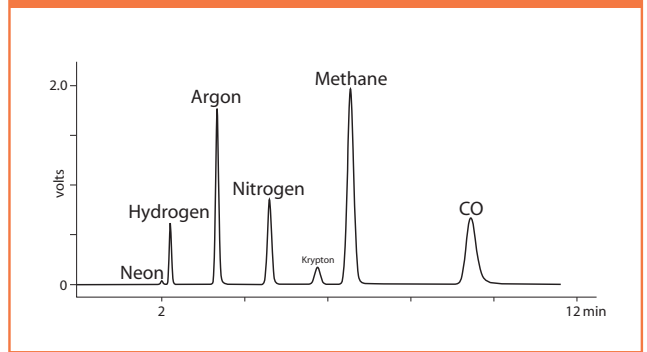

TRACE IMPURITIES in CARBON DIOXIDE 1 ml of 1 ppm blend

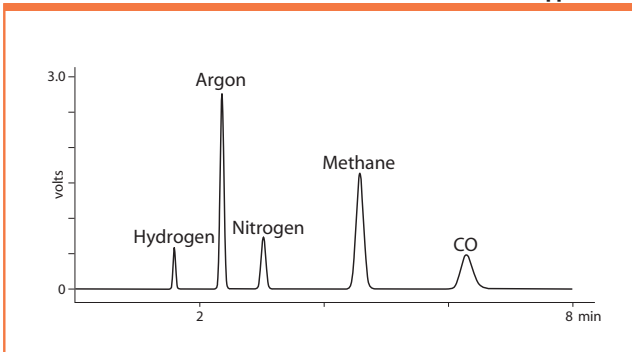

TRACE IMPURITIES in HELIUM, CHANNEL A 1 ml of 2 ppm blend

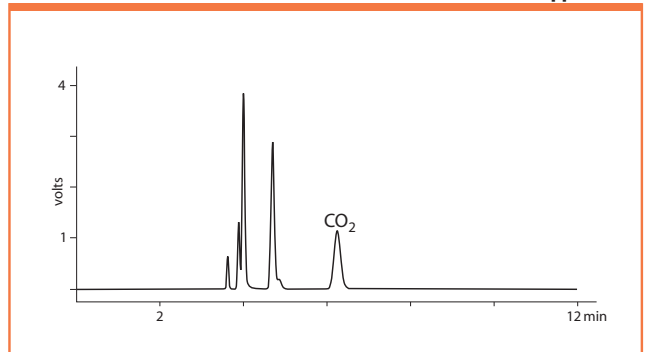

TRACE IMPURITIES in HYDROGEN 1 ml of 1 ppm blend

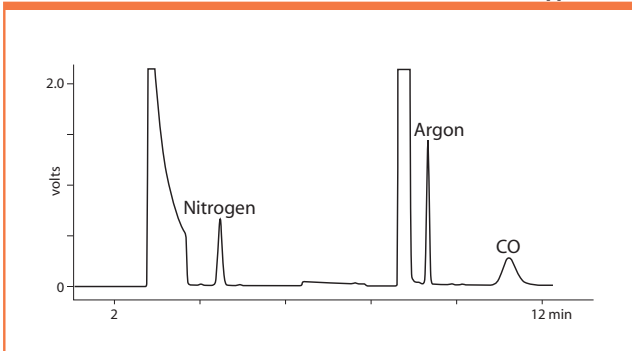

TRACE IMPURITIES in OXYGEN 1 ml of 1 ppm blend

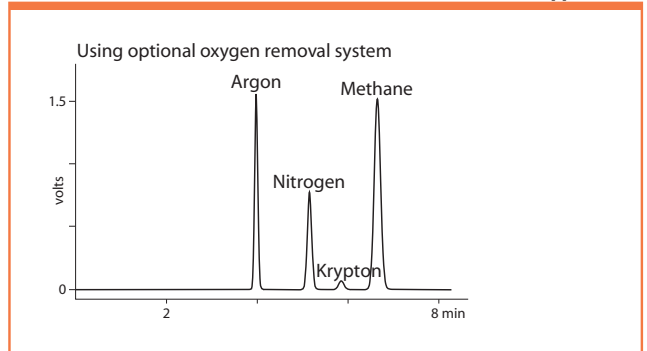

TRACE IMPURITIES in HYDROGEN BROMIDE 1 ml of 1 ppm blend

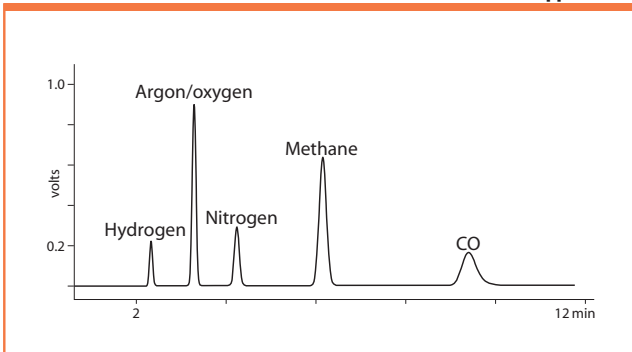

TRACE IMPURITIES in NITROGEN 1 ml of 1 ppm blend

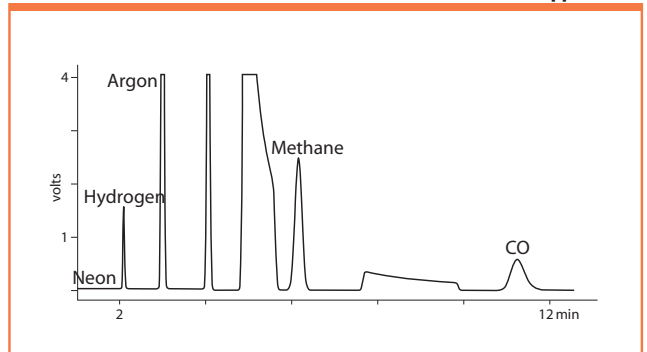

PULSED DISCHARGE DETECTORS

NON-RADIOACTIVE, MULTIPLE MODE ELECTRON CAPTURE / HELIUM PHOTOIONIZATION

VICI PDDs (pulsed discharge detectors) utilize a stable, low powered, pulsed DC discharge in helium as an ionization source. Eluants from the column, flowing counter to the flow of helium from the discharge zone, are ionized by photons from the helium discharge. The bias electrode(s) focus the resulting electrons toward the collector electrode, where they cause changes in the standing current which are quantified as the detector output. Performance is equal to or better than detectors with conventional radioactive sources.

In the electron capture mode, the PDD is a selective detector for monitoring high electron affinity compounds such as freons, chlorinated pesticides, and other halogen compounds. For this type of compound, the minimum detectable quantity (MDQ) is at the picogram (10^{-12}) or femtogram (10^{-15}) level.

In the helium photoionization mode, the PDD is a universal, non-destructive, high sensitivity detector. The response to both inorganic and organic compounds is linear over a wide range. Response to fixed gases is positive (increase in standing current), with an MDQ in the low ppb range.

The PDD in helium photoionization mode is an ideal replacement for FIDs in petrochemical or refinery environments, where the hydrogen and flame can be problematic. In addition, when the discharge gas is doped with argon, krypton, or xenon (depending on the desired cutoff point), the PDD functions as a specific photoionization detector for selective determination of aliphatics, aromatics, amines, and other species.



R&D 100
AWARD WINNER

➔ SEE ALSO

- Pulsed discharge detectors
- miniPDD page 212
 - Model D-2 211
 - Model D2-IM 212
 - Model D-3 213
 - Model D-4 213
- Plug-and-play detectors
- for Agilent 6890 213
 - for Agilent 7890 213
 - for other GCs 213
- Trace gas analyzers 206-209

MODEL D-2

The D-2 is a dual mode, universal detector system which can be retro-fitted to your older GC. The D-2-I is optimized for trace level work in the helium photoionization mode. The stand-alone systems include detector, controller, electrometer, HP2 helium purifier (see page 216), and power supply.

PDD Model D-2

CE

STAND-ALONE SYSTEM

Detector system includes detector cell, pulser, controller, electrometer, and helium purifier.

	110 VAC Prod No	230 VAC Prod No
Mode-selectable universal electron capture / photoionization detector system	D-2	D-2-220
Detectors optimized for trace level work in helium photoionization mode. Optimized for packed column use.	D-2-I	D-2-I-220

SCHEMATIC – MODEL D-2

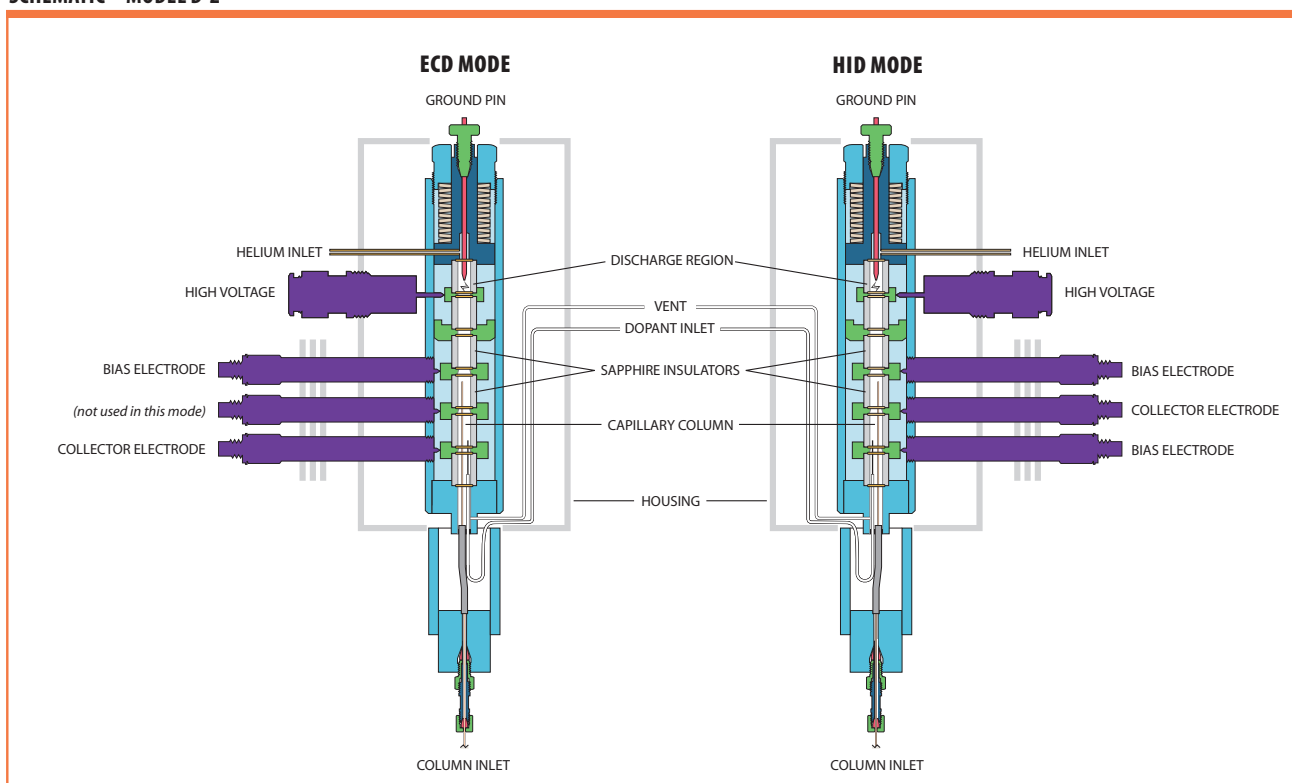

miniPDD HELIUM IONIZATION DETECTORS

The newest member of the PDD family is also the smallest and thriftiest. The miniPDD uses about one fifth (20%) the amount of helium as the D-3 and D-4 versions, giving up only a bit of sensitivity and dynamic range in return. It is approximately one half the size of the D-4, but has nearly the same sensitivity – about 100 ppb for fixed gases. With its reduced size, weight, and helium consumption, it is particularly well suited to portable applications, or to any situation in which the high cost of helium becomes a consideration.

The miniPDD system includes a controller, with integral electrometer, pulser, helium purifier, and fittings kit. The fittings kit includes almost everything the customer might need to connect and run the detector in a chromatographic system.

The new D-3-IM-7890 makes installation on the 7890 GC as simple as the standard D-3-I-7890. Just plug and play. Includes everything you need to get going, fast and easy.

Models D-2-IM and D-3-IM-7890 C E HELIUM PHOTOIONIZATION

Detector cell only optimized for helium photoionization mode

		<i>Prod No</i>	
miniPDD system	Includes: Controller Pulser Helium purifier Fittings kit	PD-C2 PD-M2 HP2 PD-Kit-IM	D-2-IM
miniPDD plug-in system for Agilent 7890		110 VAC	D-3-IM-7890
		230 VAC	D-3-IM-7890-220
miniPDD cell only			PD-D2-IM

SCHEMATIC – MODEL D-2-IM

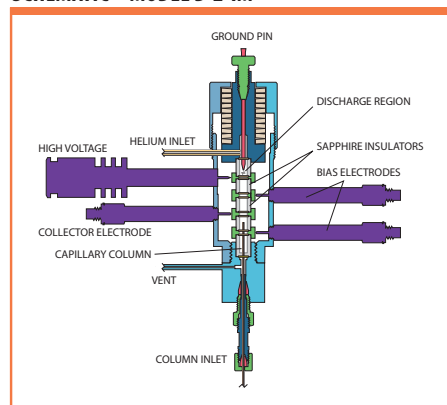

miniPDD – MODEL D-2-IM

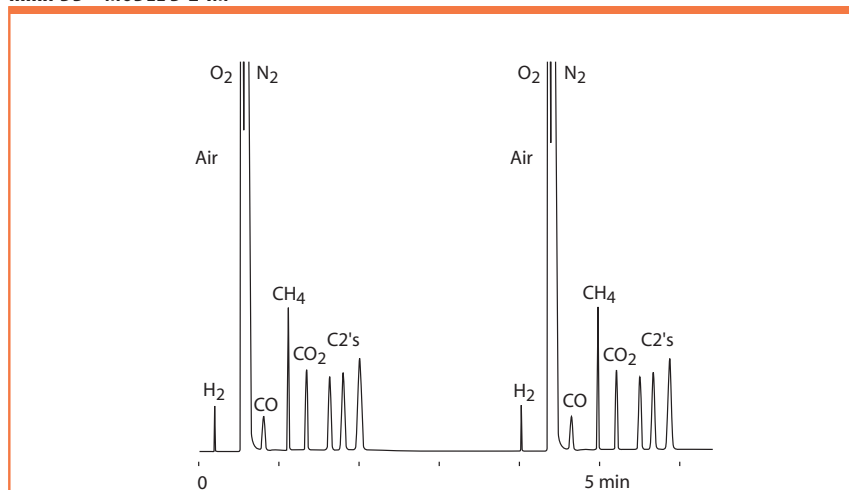

TWO CONSECUTIVE RUNS OF LIGHT HYDROCARBONS IN AIR

Detector: miniPDD Model PD-2-IM
 Detector temp: 150°C
 Column: 100/120 ShinCarbon
 1.4 m x 0.53 mm Silcosteel
 Resistive heat: 30°C (0.9 min) to 230°C
 at 100°C/min (hold 1 min)
 Sample: 2000 ppm in air, 2 µl size
 Carrier: Helium
 Discharge gas: Helium

PLUG-AND-PLAY DETECTORS FOR AGILENT 7890 AND 6890

Model D-3 is designed for plug-and-play installation on the popular Agilent 6890 and 7890, and is optimized for trace level work in the helium photoionization mode.

Both versions utilize the electronics and power supply of the host GC.

PDD Model D-3

HELIUM PHOTOIONIZATION

Detector optimized for trace level work in helium photoionization mode

		110 VAC	230 VAC
		Prod No	Prod No
Plug-in system for Agilent 7890	Standard	D-3-I-7890	D-3-I-7890-220
	miniPDD	D-3-IM-7890	D-3-IM-7890-220
Plug-in system for Agilent 6890		D-3-I-HP	D-3-I-HP-220

SCHEMATIC – MODEL D-3

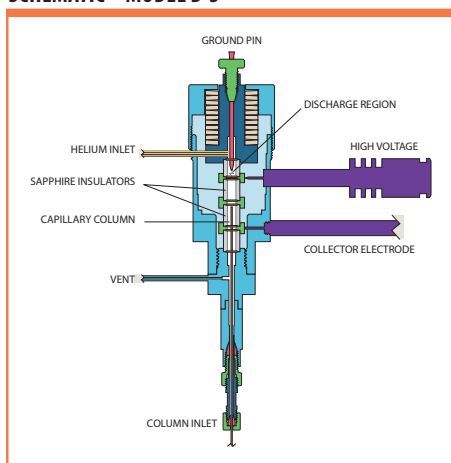

D-3-I-HP PLUG-IN SYSTEM for Agilent 6890 GC

PLUG-AND-PLAY DETECTORS FOR OTHER GCs

Pulsed Discharge Detector Model D-4 is available in versions for easy installation on most of the GCs in current use, including the Varian 3800; Shimadzu 14, 17, 2010, and 2014;

ThermoFinnigan Trace, Mega, and Top; and Hewlett Packard 5890. The D-4 is single mode, optimized for trace level work in the helium photoionization mode.

SCHEMATIC – MODEL D-4

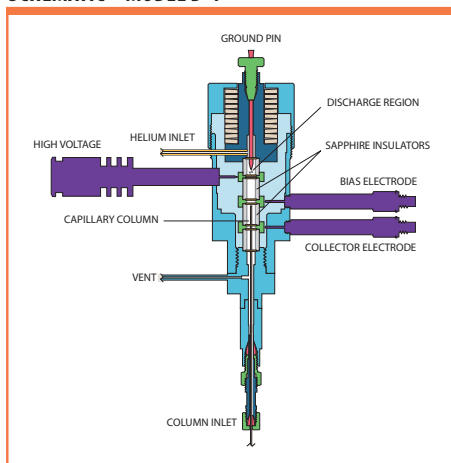

PDD Model D-4

HELIUM PHOTOIONIZATION

Detectors optimized for trace level work in helium photoionization mode

		110 VAC	230 VAC
		Prod No	Prod No
Specialized detector for	HP 5890	D-4-I-HP58	D-4-I-HP58-220
	Shimadzu GC 14 *	D-4-I-SH14-R	D-4-I-SH14-R-220
	Shimadzu GC 17, 2010, 2014 *	D-4-I-SH17-R	D-4-I-SH17-R-220
	Thermo Trace GC *	D-4-I-TQ-R	D-4-I-TQ-R-220
	Varian 3800 *	D-4-I-VA38-R	D-4-I-VA38-R-220
* Uses existing GC FID electrometer.			
For all other GCs		D-4-I	D-4-I-220

Pulsed discharge detector • Applications

INSTRUMENTATION

PDD – MODEL D-2

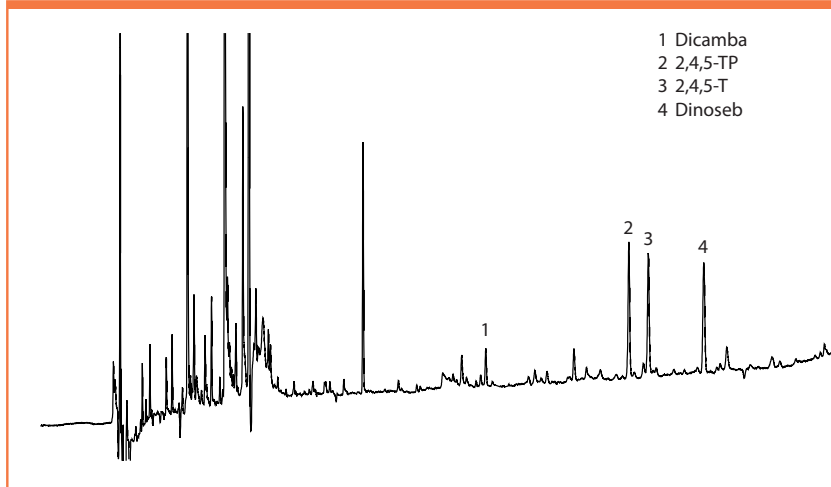

HERBICIDES IN SOIL SAMPLES USING EPA METHOD 8151

Detector: PDD Model D-2
Mode: Electron capture
Sample: Environmental soil (1 g)
Detector temp: 320°C
Column: ValcoBond VB-5
30 m x 0.25 mm x 0.25 µm
Column temp: 60°C (2 min),
20°C/min to 180°C,
4°C/min to 220°C,
40°C/min to 300°C (5 min)
Injector temp: 200°C
Sample volume: 2 µl (solvent microextraction), 1:15 split
Discharge gas: Helium
Dopant gas: Helium/argon
Attenuation: 1

PDD – MODEL D-2

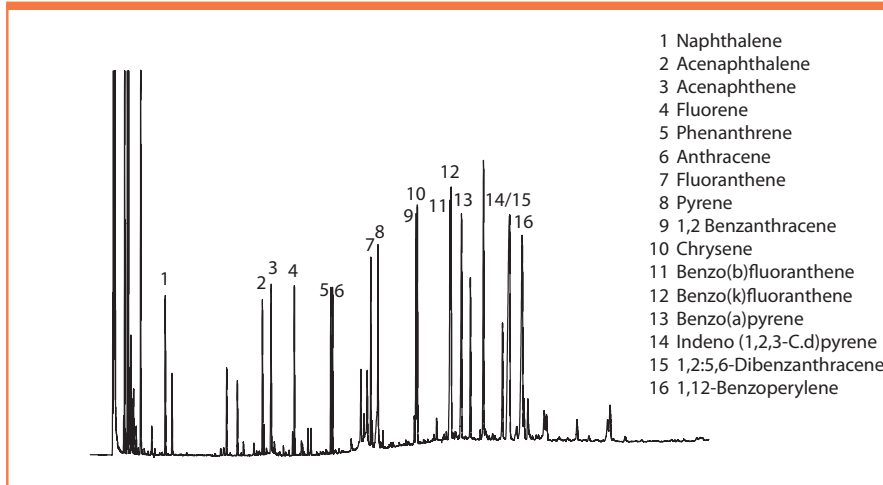

PAH RESIDUES IN AN ENVIRONMENTAL SOIL SAMPLE SPIKE

Detector: PDD Model D-2
Mode: Helium photoionization
Sample: Environmental soil (1 g)
Detector temp: 300°C
Column: ValcoBond VB-35
30 m x 0.25 mm x 0.25 µm
Column temp: 120°C for 3 min, 15°C/min
to 310°C for 15 min
Injector temp: 275°C
Sample volume: 2 µl (solvent microextraction), 1:15 split
Discharge gas: Helium
Dopant gas: none
Attenuation: 1

miniPDD – MODEL D-2-IM

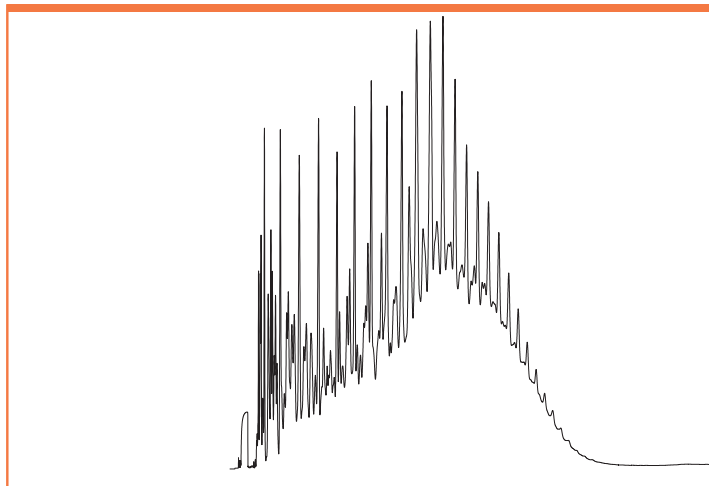

SIMULATED DISTILLATION IN TWO MINUTES

Detector: miniPDD
Detector temp: 320°C
Column: ValcoBond® VB-1
5 m x 0.25 mm x 0.20 µm
Column temp: 40°C initial for 0.1 min
to 320°C at 150°C/min
Injector temp: Cold on-column injection
Carrier gas: Helium
Reference gas: Helium
Sample: Reference Gas Oil (RGO)
provided by
Separation Systems, Inc.

PDD – MODEL D-3

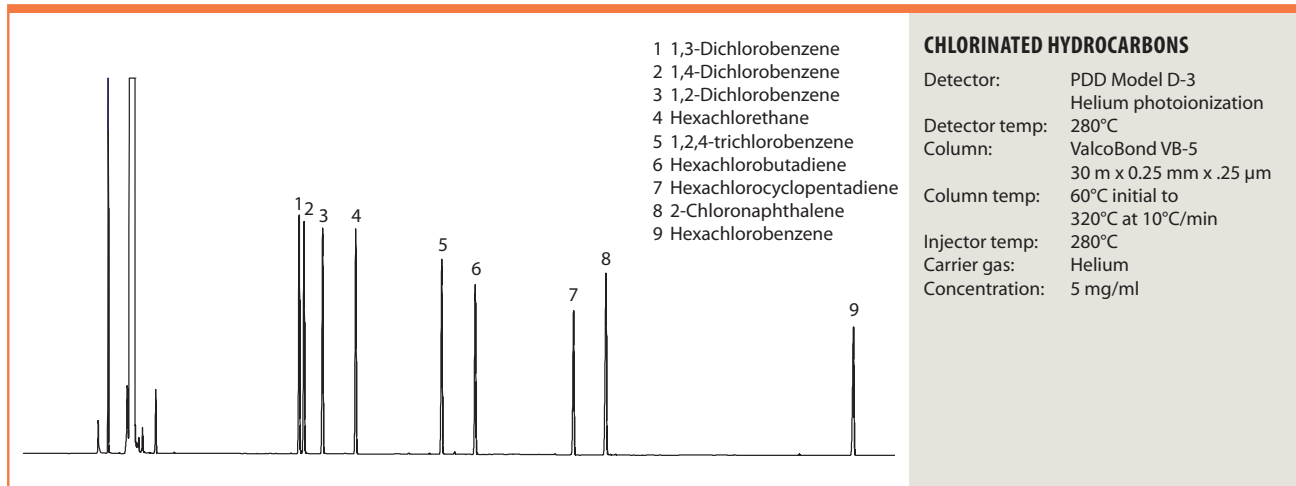

CHLORINATED HYDROCARBONS

Detector: PDD Model D-3
 Helium photoionization
 Detector temp: 280°C
 Column: ValcoBond VB-5
 30 m x 0.25 mm x .25 µm
 Column temp: 60°C initial to
 320°C at 10°C/min
 Injector temp: 280°C
 Carrier gas: Helium
 Concentration: 5 mg/ml

PDD – MODEL D-3

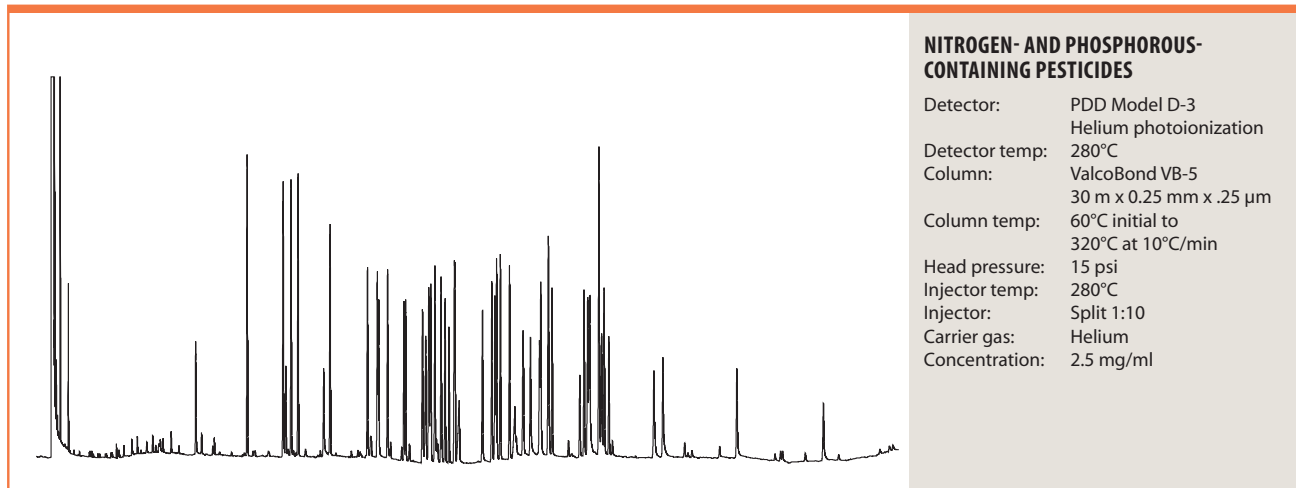

NITROGEN- AND PHOSPHOROUS-CONTAINING PESTICIDES

Detector: PDD Model D-3
 Helium photoionization
 Detector temp: 280°C
 Column: ValcoBond VB-5
 30 m x 0.25 mm x .25 µm
 Column temp: 60°C initial to
 320°C at 10°C/min
 Head pressure: 15 psi
 Injector temp: 280°C
 Injector: Split 1:10
 Carrier gas: Helium
 Concentration: 2.5 mg/ml

PDD – MODEL D-3

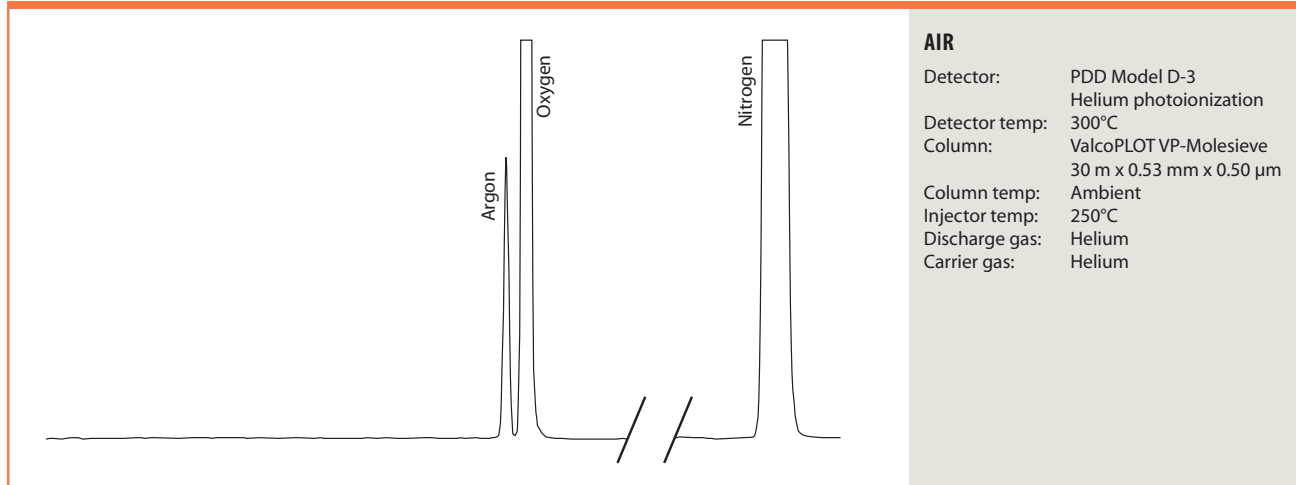

AIR

Detector: PDD Model D-3
 Helium photoionization
 Detector temp: 300°C
 Column: ValcoPLOT VP-Molesieve
 30 m x 0.53 mm x 0.50 µm
 Column temp: Ambient
 Injector temp: 250°C
 Discharge gas: Helium
 Carrier gas: Helium

HELIUM AND NITROGEN PURIFIERS

Carrier gas purity is essential in any application requiring extreme sensitivity. Impurities limit detector sensitivity and can even destroy capillary columns

STANDARD HELIUM AND NITROGEN PURIFIERS

The Valco HP2 provides “point-of-use” purification of helium or other noble gases, such as Ar, Ne, Kr, and Xe, to sub-ppm levels of reactive gaseous impurities. The NP2 is similar, purifying nitrogen to sub-ppm levels of gaseous impurities.

The purification substrate in Valco gas purifiers is a non-evaporable gettering alloy. This stable alloy is contained in a welded assembly, so

the purifiers can be used safely in industrial applications with minimal precautions. The getter is activated by heating, which eliminates the oxide film on the particle surface and allows helium to diffuse into the bulk of the getter particles. The HP2 and NP2 feature a self-regulating design which eliminates the possibility of thermal runaway and maintains the getter material at the optimum temperature.

Standard helium and nitrogen purifiers



Includes universal power supply.

	110 VAC Prod No	230 VAC Prod No
Helium purifier	HP2	HP2-220
Nitrogen purifier	NP2	NP2-220

Replacement getter assembly	
Helium	I-23572HP2
Nitrogen	I-23572NP2

SPECIFICATIONS		
	Helium purifier	Nitrogen purifier
CE certified	Yes	Yes
Gases purified	He, Ne, Ar, Kr, Xe, Rn	N ₂ only
Max. operating pressure	1000 psig	
Impurities removed	Outlet impurities less than 10 ppb H ₂ O, H ₂ , O ₂ , N ₂ , NO, NH ₃ , CO, CO ₂ , and CH ₄ , based on 10 ppm total inlet impurities. Other impurities removed include CF ₄ , CCl ₄ , SiH ₄ and light hydrocarbons.	Outlet impurities less than 10 ppb H ₂ O, H ₂ , O ₂ , NO, NH ₃ , CO, and CO ₂ , based on 10 ppm total inlet impurities. Other impurities removed include CF ₄ , CCl ₄ , SiH ₄ and light hydrocarbons.
Impurities not removed	He, Ne, Ar, Kr, Xe, Rn	CH ₄ , He, Ne, Ar, Kr, Xe, Rn, N ₂

MINI HELIUM AND NITROGEN PURIFIERS

Valco Miniature Helium and Nitrogen Purifiers (HPM and NPM) are designed for installation in a GC’s flow path immediately upstream of the injector. They will remove any contaminants introduced by flow controllers, elastomeric tube seals, pressure regulators, crude traps, or other system components that are not completely clean and leak-tight.

Mini helium and nitrogen purifiers



Includes universal power supply.

	110 VAC Prod No	230 VAC Prod No
Helium purifier	HPM	HPM-220
Nitrogen purifier	NPM	NPM-220

SEE ALSO

Gas specific purifiers and contaminant traps pages 238-239

NEW! THERMAL CONDUCTIVITY DETECTOR

- Now with serial control or user friendly interface and control/monitor program on Windows
- Enhanced thermal stability
- Smaller, compact controller housing

Like our venerable TCD-2, our new TCD-3 is a dual filament, stand-alone unit consisting of the detector housing and separate controller. However, the analog controls of the TCD-2 are replaced with full digital control implemented via a user interface or command console commands. Thermal stability is maintained in the detector to within 0.010°C, producing a stable, low-noise signal.

The TCD-3 controller generates an independent analog output signal for each of the detector filaments. In addition, a referenced analog output signal is generated by subtracting the output signal of one filament channel from the other. Each of these three output signals is provided in two full-scale spans: a ±1 volt scale and a ±10 volt scale.

TCD CONTROL PROGRAM

The Windows-based control program makes it easy to set parameters such as detector temperature and filament power and to monitor unit performance.

SCREEN CAPTURE – CONTROL SCREEN



SCREEN CAPTURE – GRAPH SCREEN



TCD Thermal conductivity detectors



		110 VAC	230 VAC
		<i>Prod No</i>	<i>Prod No</i>
Entire unit (cell, electronics, power supply, cables, and fittings)	Nickel-iron filaments	TCD3-NIFE	TCD3-NIFE-220
	Tungsten-rhenium filaments	TCD3-WRE	TCD3-WRE-220
Cell/oven assembly only, dual filament	Nickel-iron filaments	TCD3-NIFED	TCD3-NIFED-220
	Tungsten-rhenium filaments	TCD3-WRED	TCD3-WRED-220
TCD controller only		TCD3-C	TCD3-C-220